

Job Name: _____
 Location: _____
 Engineer: _____
 Submitted to: _____
 Submitted by: _____
 Reference: _____

Date: _____
 Approval: _____
 Construction: _____
 Unit #: _____
 Drawing #: _____



INDOOR UNIT FEATURES:

- LED display
- WiFi Ready
- Quiet operation
- Multiple fan speeds (LOW/MED/HI/TURBO)
- Easy to remove filters
- Adjustable louvers



This warranty should be registered on our website www.cooperandhunters.us within 60 days of installation. The warranty is only valid when installed by a Licensed HVAC Technician. A warranty period of Seven (7) years on compressor to the original registered end-user. A warranty period of Five (5) years on all parts to the original registered end-user. Warranty applies only to products remaining in their original installation location.

Power source	V, Ph, Hz	208/230, 1, 60	
Cooling capacity (Nominal)	Btu/h	9,000	
Heating capacity (Nominal)	Btu/h	10,000	
Minimum Circuit Ampacity (MCA)	A	3	
Maximum Overcurrent Protection (MOCP)			
Max. fuse size	A	15	
Dimensions (HxWxD)	inch	31.57x7.87x11.61	
Net weight	lbs	18.96/24.25	
Heat exchanger		Cross fin (Aluminum fin and copper tube)	
Fin coating		Gold	
Fan	Type / quantity		
	External Static pressure	in. WG	
	Airflow rate	CFM	291.18/194.12/152.94
	Motor type		DC Motor
Sound pressure level	dB	40/34/23.5	
Diameter of refrigerant pipe (O.D.)	Liquid	inch	1/4 Flare
	Gas	inch	3/8 Flare
Diameter of drain pipe	inch		5/8

Unit: mm/inch

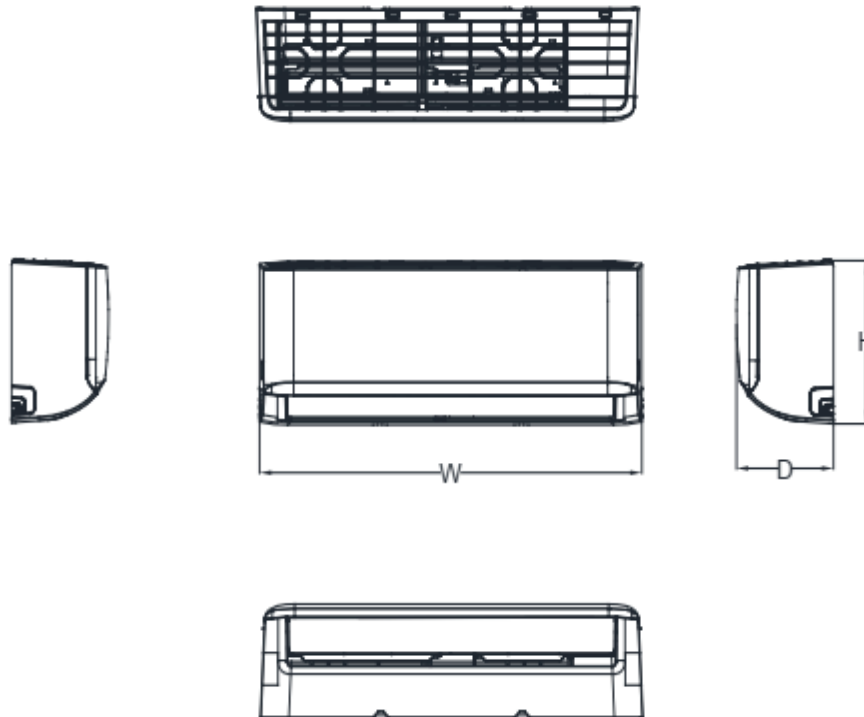

Capacity	Body Code	W(mm/inch)	D(mm/inch)	H(mm/inch)
6K~11K	A	729/28.7	200/7.87	292/11.5
8K~14K	B	802/31.57	200/7.87	295/11.61
12K~21K	C	971/38.23	228/8.98	321/12.64
18K~28K	D	1082/42.6	234/9.21	337/13.27
27K~36K	F	1259/49.57	283/11.14	362/14.25